

LB-34-15-A Standard Gain Horn Antenna 22-33GHz 15dB Gain
Rectangular Waveguide Interface



Standard Gain Horn Antenna Operating From 22GHz to 33GHz With a Nominal 15dB Gain With Rectangular Waveguide Interface

Product Information

SKU	LB-34-15-A
-----	------------

Description

Standard Gain Horn Antenna LB-34-15-A, operating from 22 to 33GHz with a nominal 15dB gain and low VSWR 1.15:1 with FBP260 output. The model LB-34-15-A has uniform gain through its frequency span, providing efficient performance characteristics and directionality. Constructed of lightweight corrosion-resistant aluminum, the antenna will provide years of trouble-free indoor and outdoor service. This standard gain horn antenna is linearly polarized and ideally suited for EMI testing, direction finding, surveillance, antenna gain and pattern measurements and other applications.

Technical Specification

Electrical Specification		Interface	
Frequency, Min (GHz)	22	Output Type	Waveguide
Frequency, Max (GHz)	33	Flange Style	Square
Waveguide Type	Rectangular	Flange Type	Cover
Waveguide Size EIA WR	WR34	Flange Designation	FBP260(UBR260)
Gain, Typ (dBi)	15	Connector Gender	N/A
Polarization	Linear	Mechanical Specification	
3dB Beamwidth, E-Plane, Typ (Deg.)	26	Figure	A Type
3dB Beamwidth, H-Plane, Typ (Deg.)	25	Body Material	Cu
Cross Pol. Isolation, Typ (dB)	40	Finish	Silver Plated, Gray Paint
VSWR, Typ	1.15:1	Size, W (mm)	31
		Size, H (mm)	22
		Size, L (mm)	42
		Weight, (kg)	0.05

Additional Information

Application	General Purpose Indoor & Outdoor, Fixed	Solution for	Gain Reference Antenna Measurement Reflector Feed Far-field Measurement System Intergration Material Measurement
-------------	---	--------------	---

Outline Drawing

FBP260 Output (P/N: LB-34-15-A)

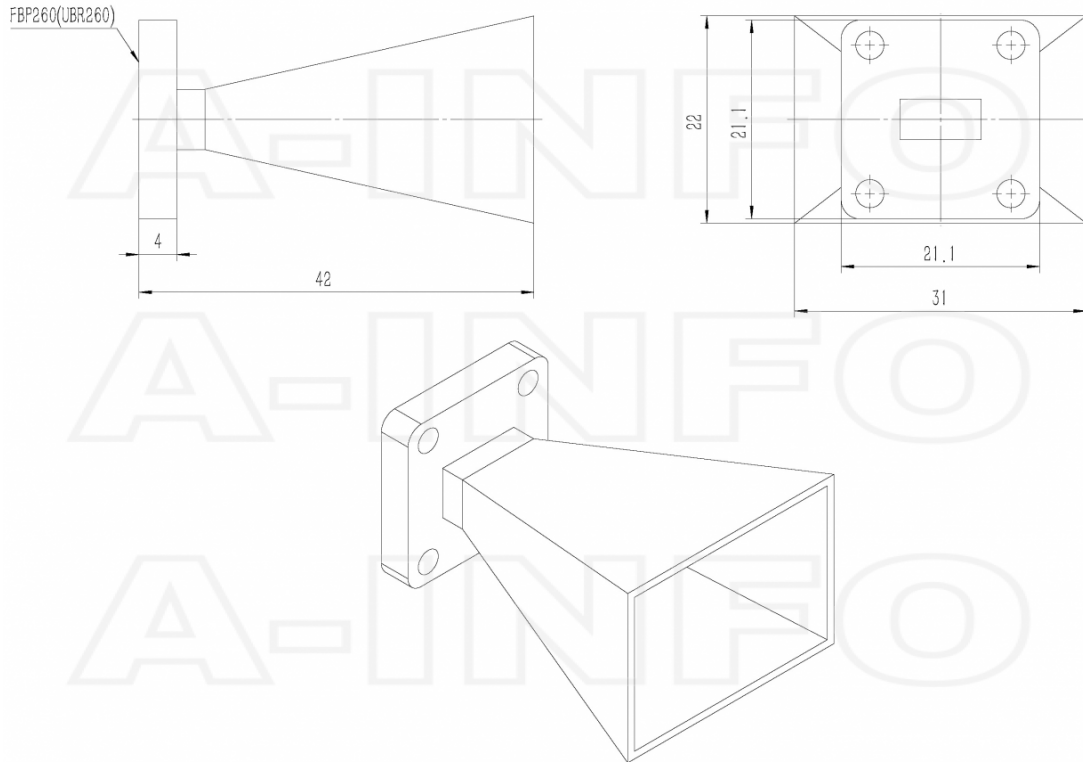

Flange Drawing

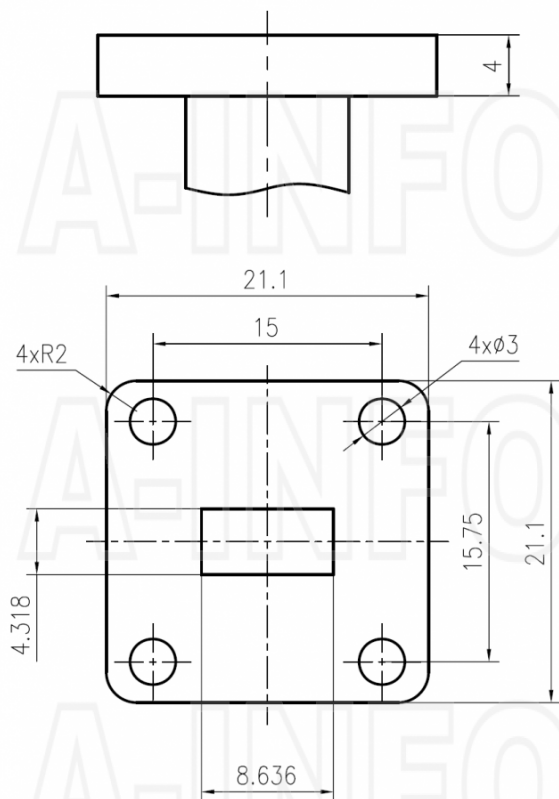

FBP260

Typical Test Results

Gain

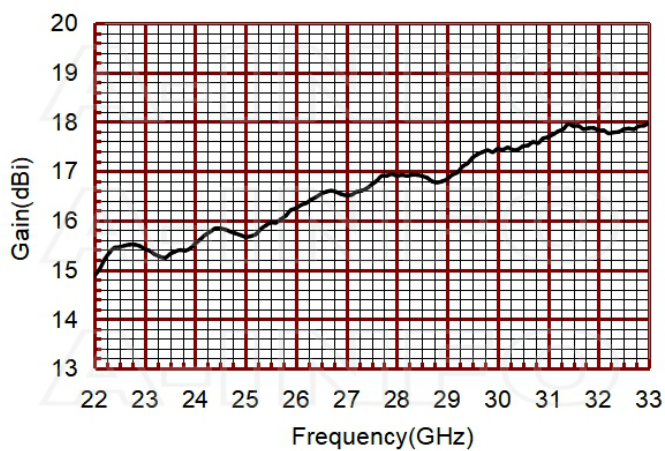

Antenna Factor

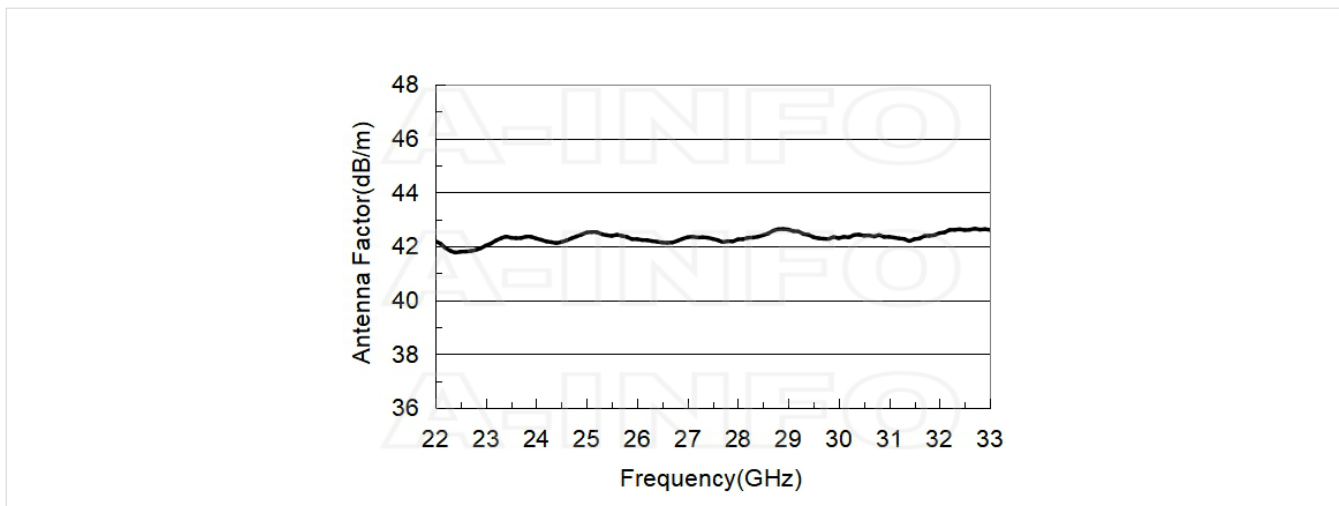

Antenna Factor (Table)

Frequency (GHz)	Gain (dBi)	Antenna Factor (dB/m)	Frequency (GHz)	Gain (dBi)	Antenna Factor (dB/m)
22.00	14.87	42.19	28.00	16.90	42.25
22.50	15.46	41.80	28.50	16.90	42.41
23.00	15.42	42.02	29.00	16.84	42.62
23.50	15.32	42.32	29.50	17.27	42.34
24.00	15.53	42.29	30.00	17.45	42.30
24.50	15.84	42.16	30.50	17.50	42.39
25.00	15.66	42.51	31.00	17.69	42.35
25.50	15.95	42.39	31.50	17.91	42.26
26.00	16.25	42.26	32.00	17.82	42.49
26.50	16.54	42.14	32.50	17.85	42.60
27.00	16.51	42.33	33.00	17.97	42.61
27.50	16.72	42.27			

Cross Polarization Isolation

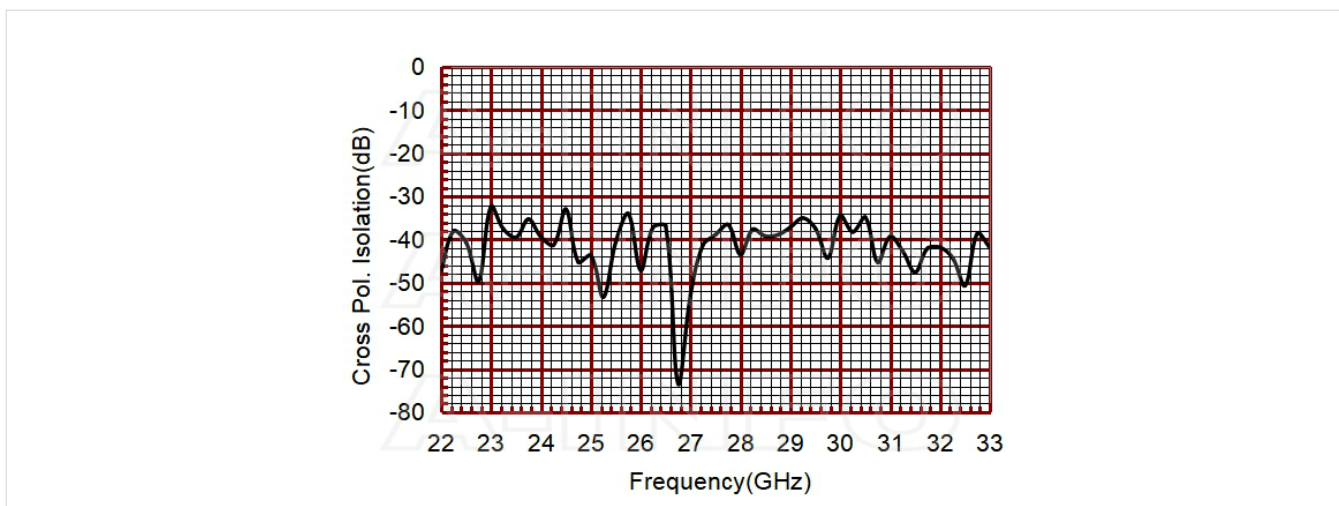

VSWR

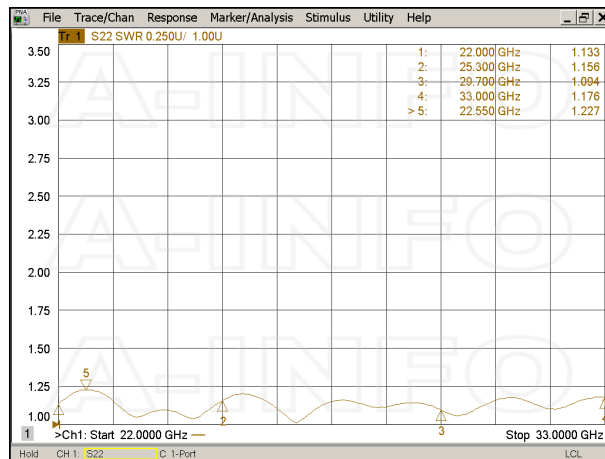

Pattern

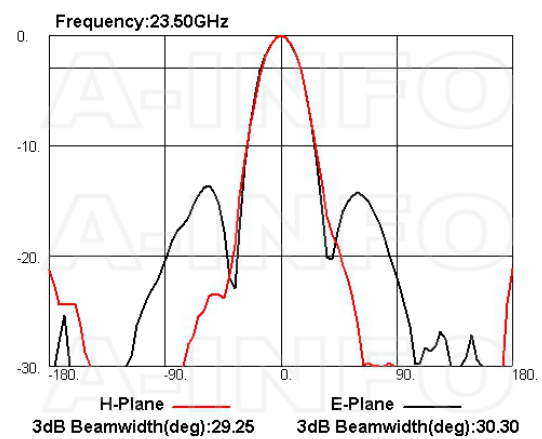
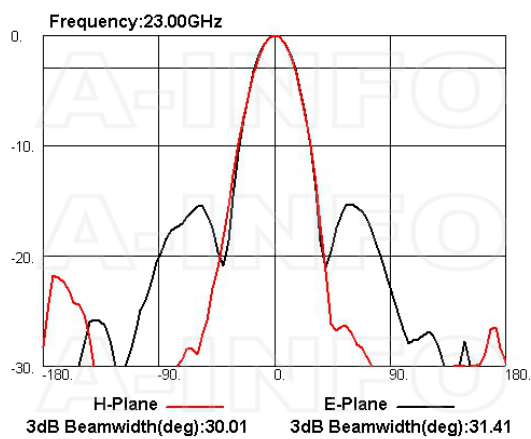
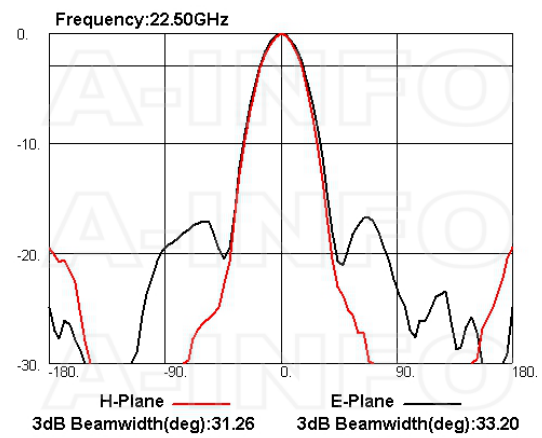
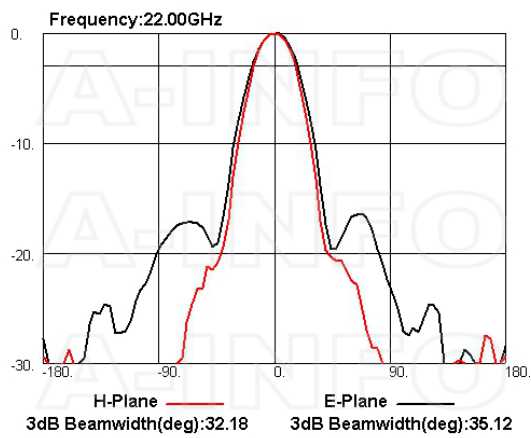

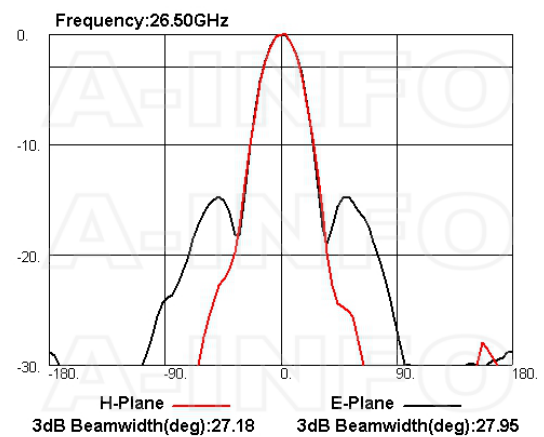
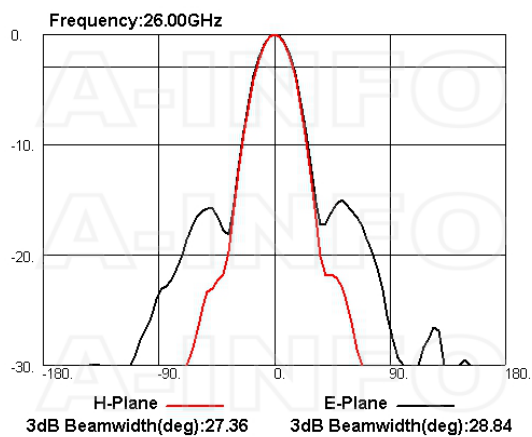
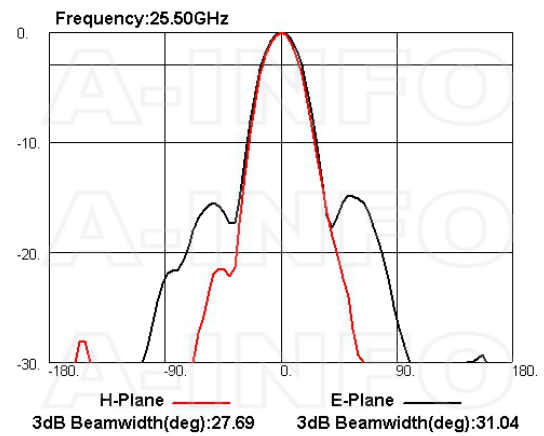
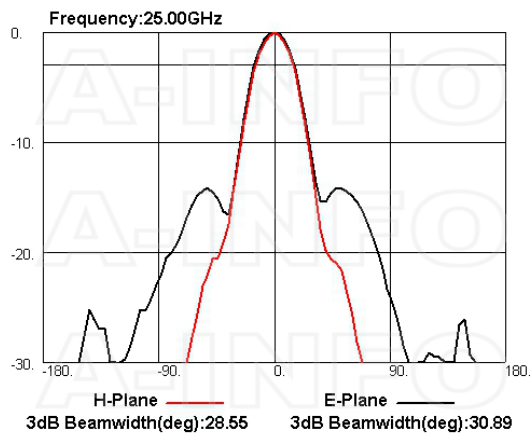
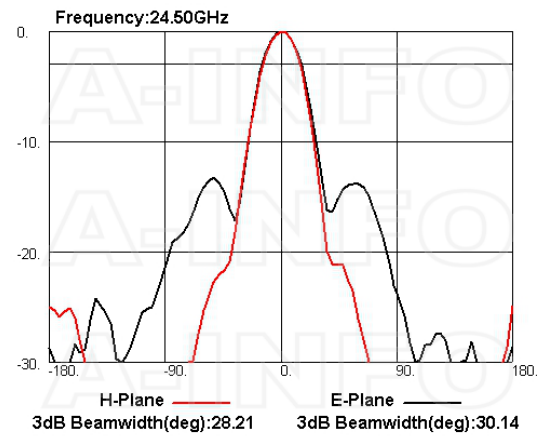
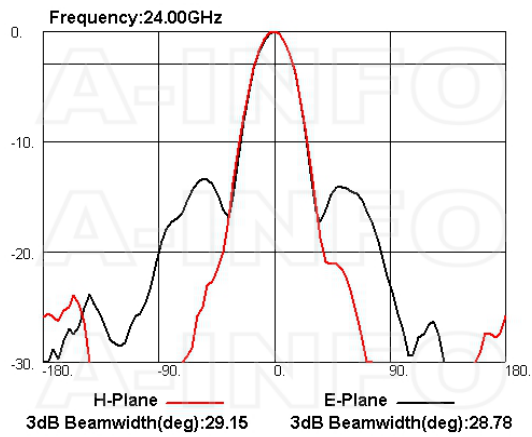

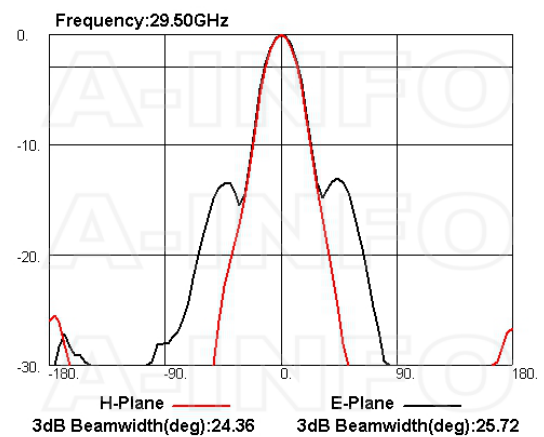
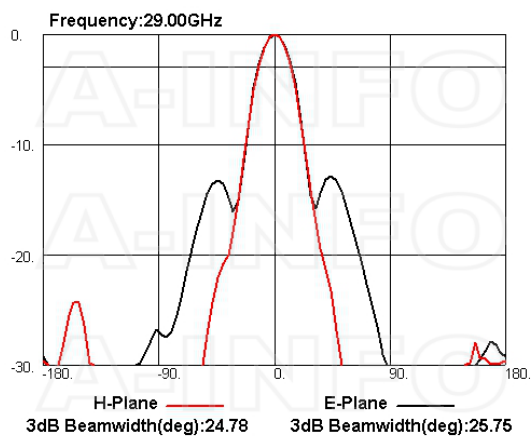
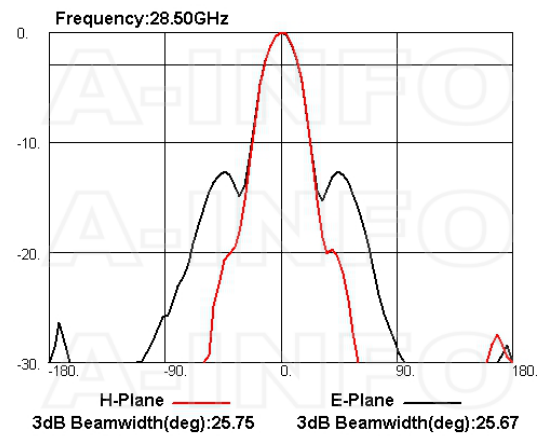
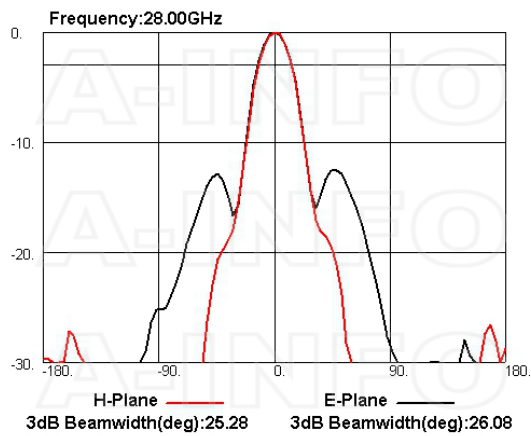
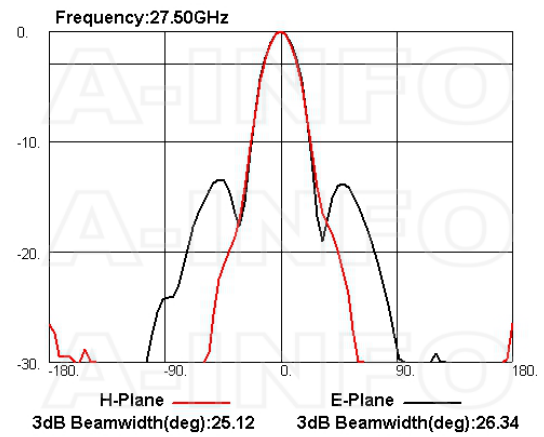
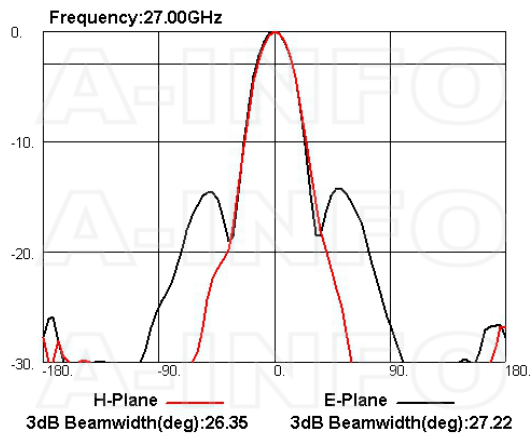

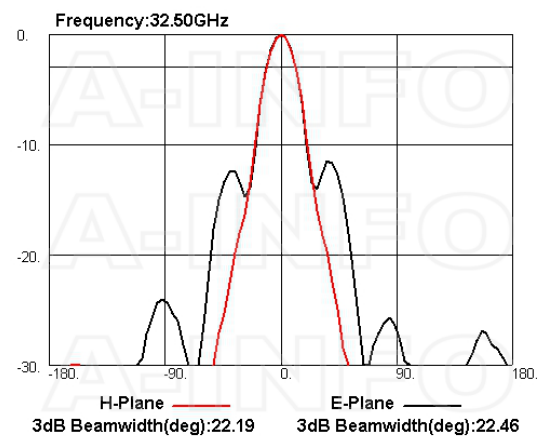
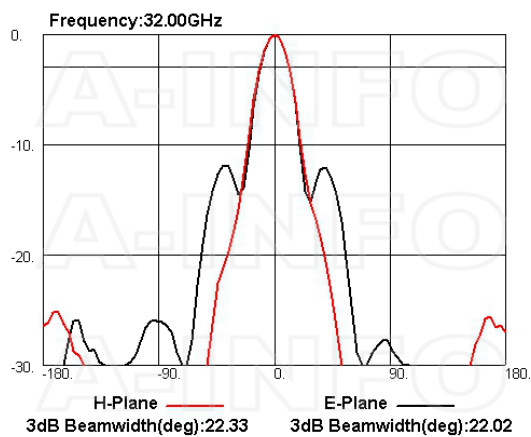
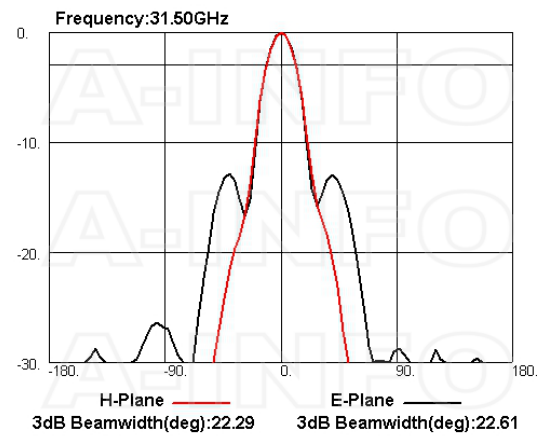
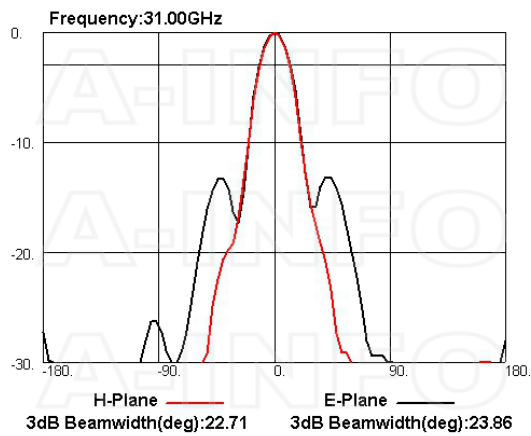
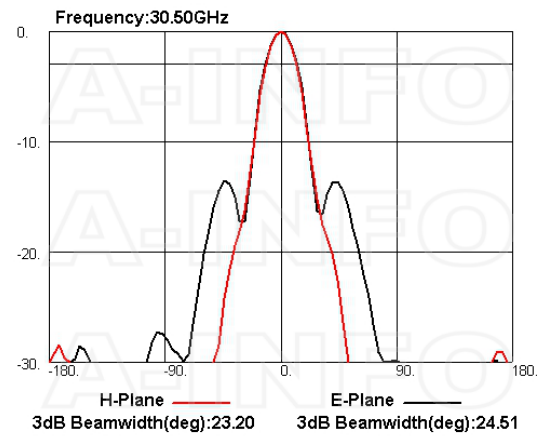
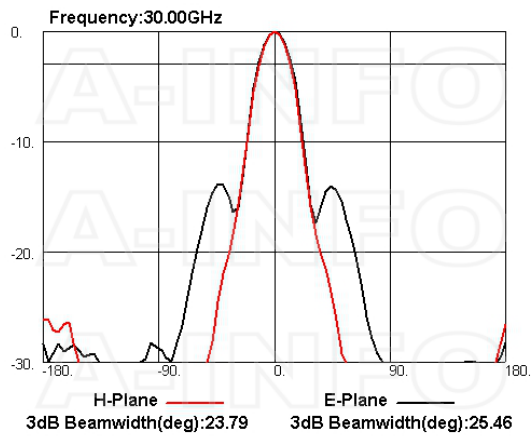

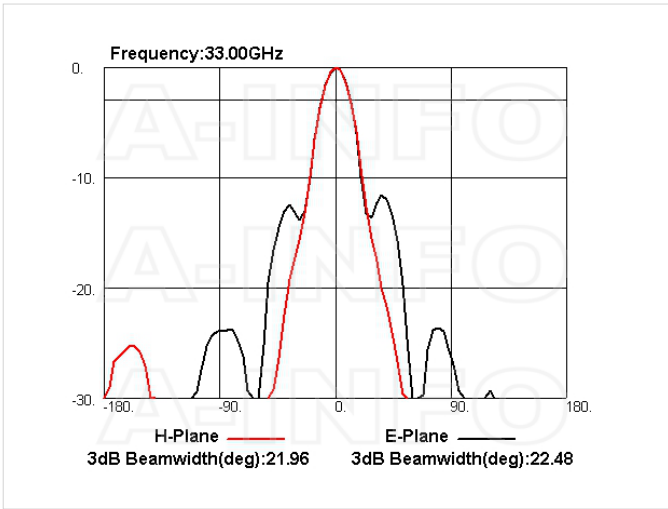

Related Products



34WCAK_Cu Right Angle Rectangular Waveguide to Coaxial Adapter 22-33GHz WR34 to 2.92mm Female



34WCAKM_Cu Right Angle Rectangular Waveguide to Coaxial Adapter 22-33GHz WR34 to 2.92mm Male



34WCA2.4_Cu Right Angle Rectangular Waveguide to Coaxial Adapter 22-33GHz WR34 to 2.4mm Female



34WCA2.4M_Cu Right Angle Rectangular Waveguide to Coaxial Adapter 22-33GHz WR34 to 2.4mm Male



34WCA3.5_Cu Right Angle Rectangular Waveguide to Coaxial Adapter 22-33GHz WR34 to 3.5mm Female



34WCA3.5M_Cu Right Angle Rectangular Waveguide to Coaxial Adapter 22-33GHz WR34 to 3.5mm Male



34WECAK_Cu Endlaunch Rectangular Waveguide to Coaxial Adapter 22-33GHz WR34 to 2.92mm Female



M3x14 Hex_Pack WR42- WR34 Flange Assembly Pack

Similar Products

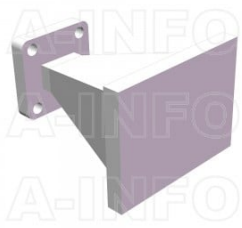

LB-34-15-ASPO Standard Gain
Horn Antenna 22-33GHz 15dB
Gain Rectangular Waveguide
Interface

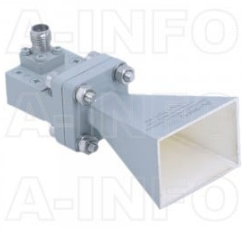

LB-34-15-C-KF Standard Gain
Horn Antenna 22-33GHz 15dB
Gain 2.92mm Female

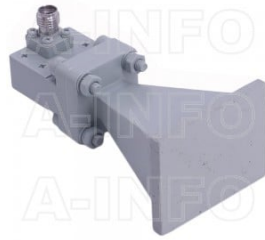

LB-34-15-C-KFSPO Standard Gain
Horn Antenna 22-33GHz 15dB
Gain 2.92mm Female

About this Datasheet

<ul style="list-style-type: none"> ● Product Information Product Link: https://www.ainfoinc.com/lb-34-15-a-standard-gain-horn-antenna-22-33-ghz-15db-gain-fbp260 Data subject to change without notice. © A-INFO INC. 2023. All Rights Reserved 	<ul style="list-style-type: none"> ● Contact Us Address:dd 60 Tesla, Irvine, CA 92618, USA Website: www.ainfoinc.com Email: sales@ainfoinc.com 	<ul style="list-style-type: none"> ● Phone & Fax Phone: +1-949-639-9688 +1-949-639-9608 Fax: +1-949-639-9670
---	--	---